

NR01微型直线导轨 Small linear guides



产品特性 Product features

- 很小安装高度6-12mm
 - 轻量级
 - 较多的滑块选项 - 有带预张力设计
 - 免维护，自润滑
 - 耐腐蚀
 - 低磨损，摩擦系数低
 - 银色阳极氧化处理
- Small installation height from 6 to 12 mm
 - Lightweight
 - Numerous carriage options – also with preload design
 - Maintenance-free, self lubricating
 - Corrosion-resistant
 - Low wear with low coefficient of friction
 - Rails in silver anodized

标准规格 Standard specifications

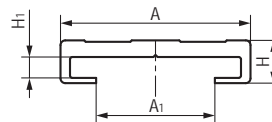
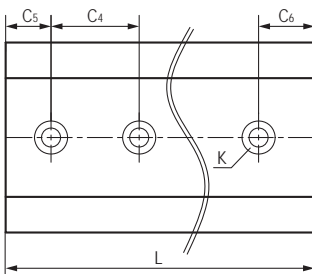

产品编码 Part No.:

NR01-17-0000-NH

空白Blank: 带安装孔 With mounting holes
NH: 无安装孔 No mounting holes

长度 Length

宽度 Width

产品编码 Part No.	A [mm]	A ₁ [mm]	C ₄ [mm]	C ₅ =C ₆ [mm]		H [mm]	H ₁ [mm]	K [mm]	L max. [mm]	重量 Weight [g/m]
				min.	max.					
NR01-17-0000	17	10.6	60	20	49.5	5.5	1.5	M3	3000	150
NR01-27-0000	27	17	60	20	49.5	9	4.4	M4	3000	290
NR01-40-0000	40	25	60	20	49.5	9	4.4	M4	3000	450

产品编码 Part No.	A [mm]	A ₁ [mm]	C ₄ [mm]	C ₅ =C ₆ [mm]		H [mm]	H ₁ [mm]	K [mm]	L max. [mm]	重量 Weight [g/m]
				min.	max.					
NR01-17-0000-NH	17	10.6	-	-	-	5.5	1.5	-	3000	150
NR01-27-0000-NH	27	17	-	-	-	9	4.4	-	3000	290
NR01-40-0000-NH	40	25	-	-	-	9	4.4	-	3000	450

NRU01导轨滑块 Guide rail sliders



产品特性 Product features

- 标准耐磨材料EPB13制成
- 多种选择：标准和带预紧设计
- 极小重量和无噪音运行
- 自润滑、免维护
- 配合导轨NR01-17和NR01-27
- 最大载荷为50N和500N
- Made of high anti-wear material EPB13
- Variants: Standard, Preload (P)
- Extrem low weight quiet running
- Maintenance-free, self lubricating
- Installation for NR01-17 and NR01-27
- Max. load 50N and 500N

标准规格 Standard specifications

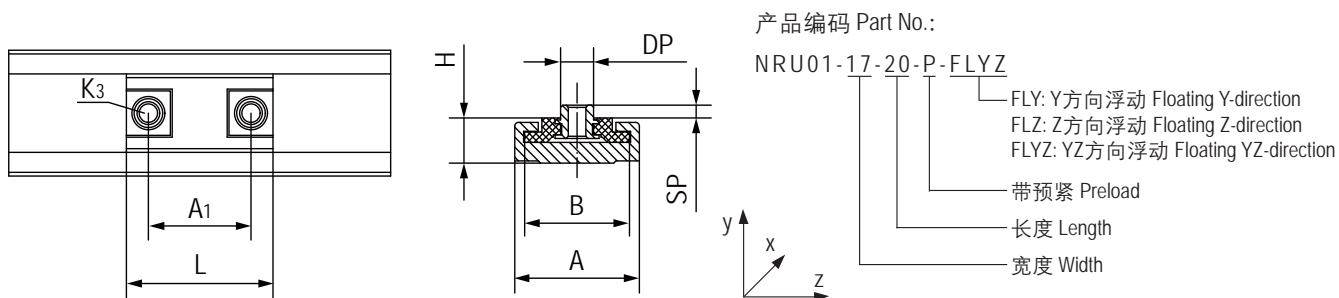

产品编码 Part No.	A [mm]	B [mm]	H [mm]	A ₁ [mm]	K ₃ [mm]	DP [mm]	SP [mm]	L [mm]	重量 Weight [g]
NRU01-17-20-P	17	14	6	14	M3	5.0	2.5	20	1.7
NRU01-27-40-P	27	24	9.9	20	M4	6.5	5	40	8
NRU01-17-20	17	14	6	14	M3	5.0	2.5	20	1.7
NRU01-17-20-FLZ	17	14	6	14	M3	5.0	2.5	20	1.7
NRU01-27-40	27	24	9.9	20	M4	6.5	5	40	8
NRU01-27-40-FLY	27	24	9.9	20	M4	6.5	5	40	8
NRU01-27-40-FLYZ	27	24	9.9	20	M4	6.5	5	40	8
NRU01-27-40-FLZ	27	24	9.9	20	M4	6.5	5	40	8

NRU02导轨滑块 Guide rail sliders



产品特性 Product features

- 标准耐磨材料EPB13制成，可选材料MN2
 - 多种选择：标准和浮动式设计
 - 极小重量和无噪音运行
 - 自润滑、免维护
 - 配合导轨NR01-27和NR01-40
 - 最大载荷为500N和700N
- Made of high anti-wear material EPB13, Available materials: MN2
 - Variants: Standard, Floating design
 - Extrem low weight quiet running
 - Maintenance-free, self lubricating
 - Installation for NR01-27 and NR01-40
 - Max. load 500N and 700N

标准规格 Standard specifications

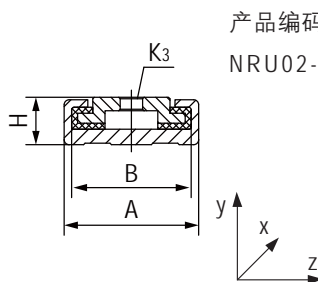
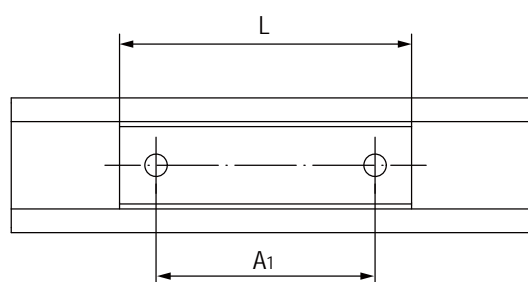

产品编码 Part No.:

NRU02-27-40-FLYZ

- FLY: Y方向浮动 Floating Y-direction
- FLZ: Z方向浮动 Floating Z-direction
- FLYZ: YZ方向浮动 Floating YZ-direction
- 长度 Length
- 宽度 Width

产品编码 Part No.	A [mm]	B [mm]	H [mm]	A ₁ [mm]	K ₃ [mm]	L [mm]	重量 Weight [g]
NRU02-27-40	27	24	9.9	20	4.5	40	8.5
NRU02-27-40-FLY	27	24	9.9	20	4.5	40	8.5
NRU02-27-40-FLYZ	27	24	9.9	20	4.5	40	8.5
NRU02-27-40-FLZ	27	24	9.9	20	4.5	40	8.5
NRU02-40-50	40	36	9.9	20	4.5	50	17
NRU02-40-50-FLY	40	36	9.9	20	4.5	50	17
NRU02-40-50-FLYZ	40	36	9.9	20	4.5	50	17
NRU02-40-50-FLZ	40	36	9.9	20	4.5	50	17
NRU02-27-80	27	24	9.9	60	4.5	80	18
NRU02-27-80-FLY	27	24	9.9	60	4.5	80	18
NRU02-27-80-FLYZ	27	24	9.9	60	4.5	80	18
NRU02-27-80-FLZ	27	24	9.9	60	4.5	80	18

NRU03导轨滑块 Guide rail sliders



产品特性 Product features

- 标准耐磨材料EPB13制成，可选材料MN2
- 多种选择：标准和浮动式设计
- 极小重量和无噪音运行
- 自润滑、免维护
- 配合导轨NR01-27和NR01-40
- 最大载荷为500N和700N
- Made of high anti-wear material EPB13, Available materials: MN2
- Variants: Standard, Floating design
- Extrem low weight quiet running
- Maintenance-free, self lubricating
- Installation for NR01-27 and NR01-40
- Max. load 500N and 700N

标准规格 Standard specifications

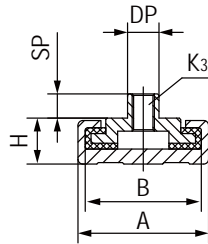
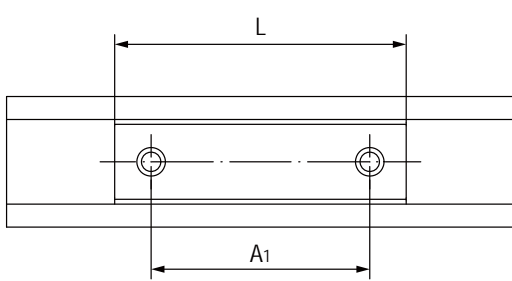

产品编码 Part No.:

NRU03-27-40-FLYZ

- FLY: Y方向浮动 Floating Y-direction
- FLZ: Z方向浮动 Floating Z-direction
- FLYZ: YZ方向浮动 Floating YZ-direction
- 长度 Length
- 宽度 Width

产品编码 Part No.	A [mm]	B [mm]	H [mm]	A ₁ [mm]	K ₃ [mm]	DP [mm]	SP [mm]	L [mm]	重量 Weight [g]
NRU03-27-40	27	24	9.9	20	M4	6.5	5	40	9
NRU03-27-40-FLY	27	24	9.9	20	M4	6.5	5	40	9
NRU03-27-40-FLYZ	27	24	9.9	20	M4	6.5	5	40	9
NRU03-27-40-FLZ	27	24	9.9	20	M4	6.5	5	40	9
NRU03-40-50	40	36	9.9	20	M4	6.5	5	50	19
NRU03-40-50-FLY	40	36	9.9	20	M4	6.5	5	50	19
NRU03-40-50-FLYZ	40	36	9.9	20	M4	6.5	5	50	19
NRU03-40-50-FLZ	40	36	9.9	20	M4	6.5	5	50	19
NRU03-27-80	27	24	9.9	60	M4	6.5	5	80	18
NRU03-27-80-FLY	27	24	9.9	60	M4	6.5	5	80	18
NRU03-27-80-FLYZ	27	24	9.9	60	M4	6.5	5	80	18
NRU03-27-80-FLZ	27	24	9.9	60	M4	6.5	5	80	18

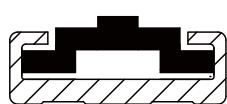
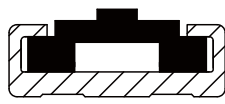
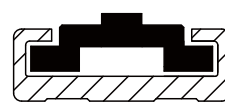
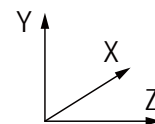
FLY

FLZ

FLYZ

产品编码 Part No.	NRU01-17	NRU01-27	NRU02-27	NRU03-27	NRU02-40	NRU03-40
FLY	0.6	0.45	0.45	0.45	0.4	0.4
FLZ	0.5	0.8	0.8	0.8	0.8	0.8
FLYZ	Y=0.6	Y=0.3	Y=0.3	Y=0.3	Y=0.4	Y=0.4
	Z=0.5	Z=0.4	Z=0.4	Z=0.4	Z=0.8	Z=0.8

NCAP导轨端盖 Guide rail end caps



产品特性 Product features

- 易安装
- 低成本
- 可拆卸
- 高压紧力
- Easy installation
- Low-priced
- Dismantling possible
- High retention force

标准规格 Standard specifications

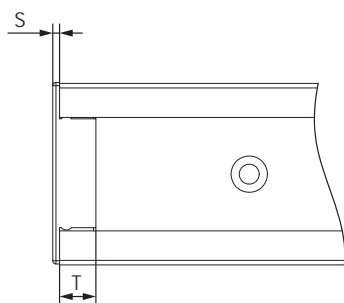

产品编码 Part No.:

 NCAP-17
 宽度 Width

产品编码 Part No.	S [mm]	T [mm]	导轨 Guide rail
NCAP-17	1.5	7	NR01-17
NCAP-27	2	8	NR01-27
NCAP-40	1.5	8	NR01-40